

CSP 150/200

Conduction-cooled capacitor

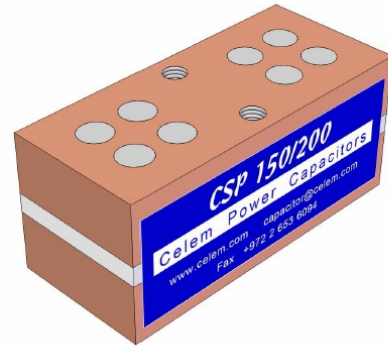

Technology Patented Worldwide

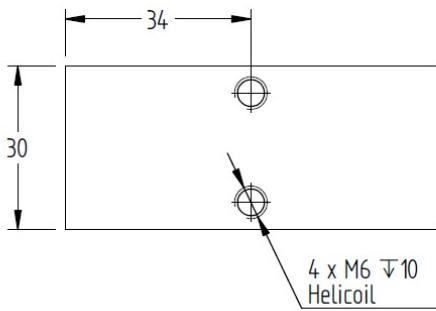
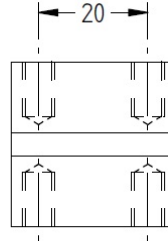
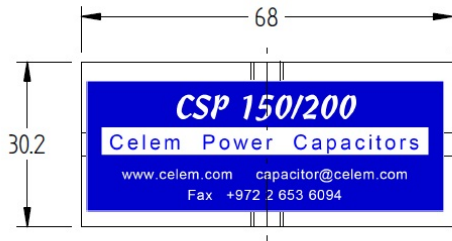

The CSP 150/200 offers superior electrical characteristics in the same physical dimensions as the CSP 150.

Please note that the newer CSP 150/400 has the same physical dimensions as the CSP150/200 but is rated for higher voltage and higher current and can carry up to 400kVAR.

Specifications

Type		CSP 150/200								
Dimensions (L x W x H)	mm	68 x 30 x 30.2								
Weight	kg	0.3								
Capacitance ($\pm 10\%$)	μF	0.05 μF	0.1 μF	0.17 μF	0.33 μF	0.5 μF	0.66 μF	1 μF	1.33 μF	2.4 μF
Sinusoidal Voltage	V _{rms}	1000	900	800	700	650	600	450		
Peak_Voltage	V	1410	1270	1130	990	919	850	640		
Max. Current	A _{rms}	250	300	350	400	450	500			
Max. Power	kVA _r	200								
Freq Range @ Full Power	kHz	637-995	318-497	231-421	151-217	99-195	98-193	75-127	66-121	65-83
Stray Inductance	nH	< 3								

Celem Power Capacitors

CSP 150/200

Conduction-cooled capacitor



Technology Patented Worldwide

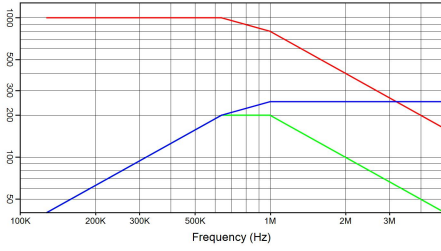

CSP 150/200 0.05 µF 1000 V_{rms} 250 A_{rms} 200 kVA_r
 I(A) — Q(kVA_r) — V_{rms} — 200 kVA_r

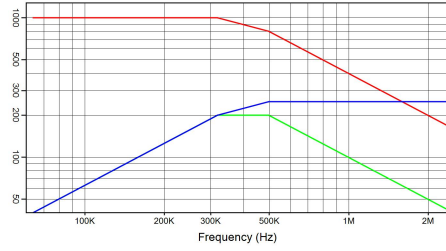

CSP 150/200 0.1 µF 1000 V_{rms} 250 A_{rms} 200 kVA_r
 I(A) — Q(kVA_r) — V_{rms} — 200 kVA_r

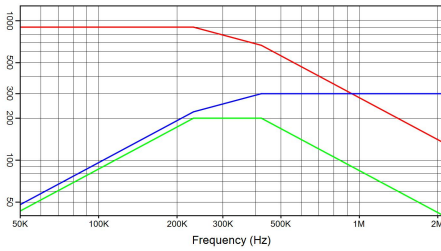

CSP 150/200 0.17 µF 900 V_{rms} 300 A_{rms} 200 kVA_r
 I(A) — Q(kVA_r) — V_{rms} — 200 kVA_r

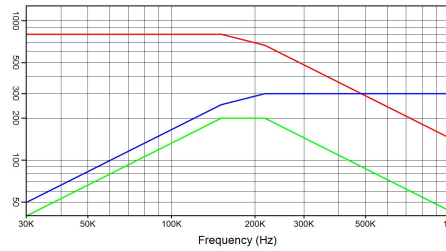

CSP 150/200 0.33 µF 800 V_{rms} 300 A_{rms} 200 kVA_r
 I(A) — Q(kVA_r) — V_{rms} — 200 kVA_r

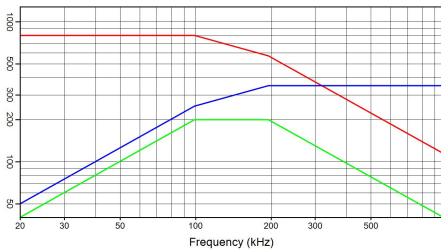

CSP 150/200 0.5 µF 800 V_{rms} 350 A_{rms} 200 kVA_r
 I(A) — Q(kVA_r) — V_{rms} — 200 kVA_r

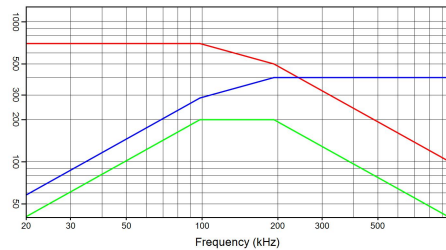

CSP 150/200 0.66 µF 700 V_{rms} 400 A_{rms} 200 kVA_r
 I(A) — Q(kVA_r) — V_{rms} — 200 kVA_r

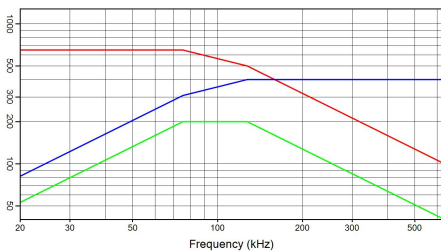

CSP 150/200 1 µF 650 V_{rms} 400 A_{rms} 200 kVA_r
 I(A) — Q(kVA_r) — V_{rms} — 200 kVA_r

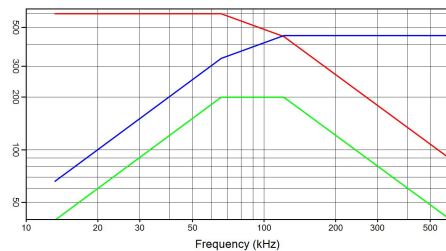

CSP 150/200 1.33 µF 600 V_{rms} 450 A_{rms} 200 kVA_r
 I(A) — Q(kVA_r) — V_{rms} — 200 kVA_r

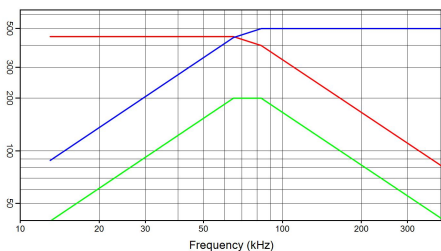

CSP 150/200 2.4 µF 450 V_{rms} 500 A_{rms} 200 kVA_r
 I(A) — Q(kVA_r) — V_{rms} — 200 kVA_r

Celem Power Capacitors

Produced: 27-01-2020